

CHEYENNE[®]

PROFESSIONAL TATTOO EQUIPMENT

HAWK PEN

+ HAWK PEN TRAY

Gebrauchsanleitung
Operating instructions
Gebruiksaanwijzing
Instructions
Istruzioni per l'uso
Instrucciones de uso

Manual de instruções
Οδηγίες
Opskrift
Bruksanvisning
Ohjeet
Instrukcja obsługi

Instrukce
Navodila nt pl za
uporabo
Utasítás
инструкции
说明

CHEYENNE[®]
PROFESSIONAL TATTOO EQUIPMENT

HAWK PEN

+ HAWK PEN TRAY

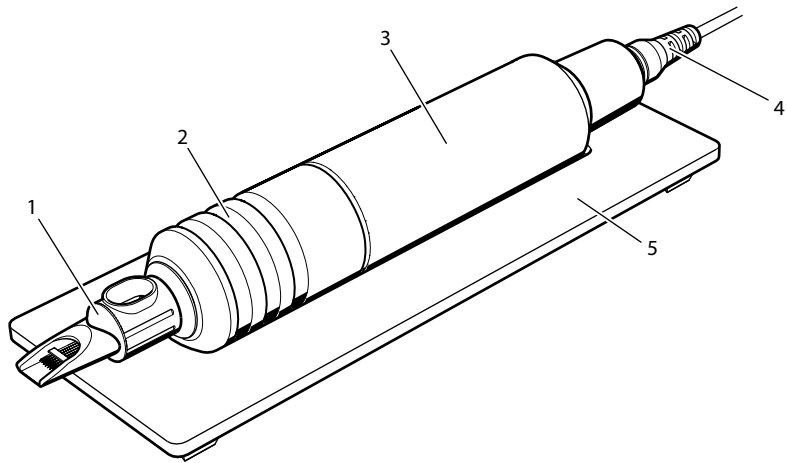

Cheyenne HAWK PEN

	1	2	3	4	5
DE	Tattoo-Modul	Griffstück	Antrieb	Anschlusskabel	HAWK PEN TRAY
EN	Safety cartridge	Handle	Drive	Power cable	HAWK PEN TRAY
NL	"Safety Cartridge"	Grip	Aandrijving	Aansluitkabel	HAWK PEN TRAY
FR	Cartouche de sécurité	Grip	Entraînement	Câble de raccordement	HAWK PEN TRAY
IT	Cartuccia di sicurezza	Impugnatura	Azionamento	Cavo di collegamento	HAWK PEN TRAY
ES	Cartucho de seguridad	Mango	Accionamiento	Cable de conexión	BANDEJA HAWK PEN
PT	Módulo de tatuagem	Pega	Motor	Cabo de conexão	HAWK PEN TRAY
EL	Safety cartridge	Λαβή	Μοτέρ	Καλώδιο σύνδεσης	HAWK PEN TRAY
DA	Safety cartridge	Gribestykke	Drev	Tilslutningskabel	HAWK PEN TRAY
SV	Säkerhetspatron	Grepp	Motor	Strömkabel	HAWK PEN TRAY
FI	Safety cartridge (turvapatruuna)	Kahvaosa	Moottori	Liitäntäjohto	HAWK PEN TRAY -alusta
PL	Kartridż bezpieczeństwa	Uchwyt	Napęd	Kabel zasilający	HAWK PEN TRAY
CS	Bezpečnostní kártridž	Rukojeť	Pohon	Připojovací kabel	HAWK PEN TRAY
SL	Varnostna kartuša	Ročaj	Pogon	Priključni kabel	Podstavek HAWK PEN TRAY
HU	Biztonsági patron	Markolat	Hajtás	Csatlakozókábel	HAWK PEN TÁLCA
RU	Картридж	Держатель	Привод	Соединительный кабель	HAWK PEN TRAY
ZH	安全针筒	手柄	驱动装置	连接线	HAWK PEN TRAY

Translation of original
operating instructions

The original operating
instructions were written
in German.

CHEYENNE
PROFESSIONAL TATTOO EQUIPMENT
**HAWK
PEN**
+ HAWK PEN TRAY

Operating instructions

Contents

1	About these operating instructions	20	5.5	Checking equipment	29
1.1	Display of warning notices.....	20	6	Using the HAWK PEN	29
1.2	Symbol used in these operating instructions.....	20	6.1	Setting the needle protrusion.....	29
2	Important safety notices	21	6.2	Setting the piercing frequency.....	29
2.1	General safety information	21	6.3	Loading with ink	30
2.2	Product-dependent safety information.....	21	7	Cleaning and maintaining the HAWK PEN	30
2.3	Important hygiene and safety regulations.....	21	7.1	Material compatibilities.....	31
2.4	Contra-indications.....	22	7.2	Disinfecting surfaces	31
2.5	Side-effects.....	23	7.3	Cleaning surfaces	31
2.6	Required qualification.....	23	7.4	Cleaning handle in an ultrasonic bath	31
2.7	Intended use	23	7.5	Sterilising handle in an autoclave.....	31
2.8	Symbols on the product.....	24	7.6	Cleaning or replacing O-rings	32
3	Scope of delivery.....	24	8	Equipment transport and storage conditions	32
4	Product info about the HAWK PEN.....	24	9	Disposal of equipment	32
4.1	Technical data	24	10	For questions or problems.....	33
4.2	Operating conditions.....	25	11	Manufacturer declarations.....	33
4.3	Accessories.....	25	11.1	Warranty declaration	33
5	Getting the HAWK PEN ready for operation .	25	11.2	Declaration of Conformity.....	34
5.1	Disinfecting equipment	25			
5.2	Replacing the safety cartridge.....	26			
5.3	Connecting the power unit	27			
5.4	Fitting the protective hose.....	28			

1 About these operating instructions



These operating instructions apply to the Cheyenne HAWK PEN and to its accessories. They contain important information about how to operate and maintain these products safely and in the intended manner.

These operating instructions do not contain all of the information needed for safe operation of the HAWK PEN and its accessories. Note the following additional documents:

- Operating instructions for the Cheyenne Power Unit and/or an external power unit and, if applicable, a foot switch
- Information about safety cartridges and tattoo inks
- Safety data sheets about disinfectants and cleaning agents
- Health and safety information and statutory provisions relating to tattooing

1.1 Display of warning notices

Warning notices draw attention to the risk of personal injury and damage to materials and are structured as follows:

 SIGNAL WORD	
Type of hazard	
Consequences	
▶ Remedy	
Element	Meaning
	Indicates a risk of injury
Signal word	Specifies the severity of the hazard (see following table)
Type of hazard	Gives the type and source of the hazard
Consequences	Describes potential consequences of non-compliance
Remedy	Indicates how to avoid a hazard

Signal word	Meaning
Warning	Indicates a hazard that can lead to death or to serious injury if the hazard is not avoided
Caution	Indicates a hazard that can lead to minor to relatively serious injury if the hazard is not avoided
Attention	Indicates potential hazards that can lead to damage to the environment, property, or the tattoo equipment if this hazard is not avoided.

1.2 Symbol used in these operating instructions

Symbol	Meaning
▶	Call for action
•	List point
-	List sub-point

2 Important safety notices



2.1 General safety information

- ▶ Read these operating instructions carefully and completely.
- ▶ Keep these operating instructions in a readily accessible location for everyone who uses, cleans, disinfects, sterilises, stores or transports the HAWK PEN.
- ▶ When handing the HAWK PEN on to another person, always enclose these operating instructions.
- ▶ Follow the safety regulations applicable to tattooing in your country. Keep your tattoo studio in a hygienic, clean condition and provide sufficient lighting.
- ▶ Use the HAWK PEN, its accessories and the power unit as well as all connecting cables in perfect technical condition.
- ▶ Only use genuine safety cartridges, accessories and spare parts from Cheyenne.

2.2 Product-dependent safety information

- ▶ Never modify the HAWK PEN, the safety cartridges or their accessories.
- ▶ Prevent fluids from entering the drive unit.
- ▶ During the tattooing process, protect the drive and its connecting cables with a protective hose (see Page 28). Also protect the HAWK PEN TRAY and the power unit with a plastic sheet.
- ▶ Whenever the HAWK PEN is not in use, switch it off and place it in the HAWK PEN TRAY so that it cannot roll away and fall to the ground.
- ▶ Note the technical data quoted in these operating instructions and comply with operating, transport and storage conditions (see Page 25).
- ▶ Hand over the HAWK PEN to a specialist retailer for inspection if it exhibits any external signs of damage or if it does not function in the usual manner.

2.3 Important hygiene and safety regulations

To prevent infectious diseases resulting from tattooing being transmitted to the customer or to the tattoo artist:

- ▶ Before use, follow the steps required to disinfect the equipment (see Page 25).
- ▶ During the tattooing process, wear disposable nitrile or latex gloves and disinfect them before use.
- ▶ Before applying a tattoo, clean the affected areas of the customer's skin with a mild cleaning and disinfectant agent. When selecting an appropriate disinfectant, take note of the applicable regulations in your country.
- ▶ For every customer and each ink, always use new, sterile-packaged safety cartridges. Before each usage, ensure that the packaging is undamaged and that the use-by date has not passed.
- ▶ Dispose of used or defective safety cartridges in a sharps container (safety box) in accordance with the regulations applicable in your country.

- ▶ Prevent safety cartridges coming into contact with contaminated objects, e.g. clothing. Dispose of contaminated safety cartridges immediately.
- ▶ Always use dermatologically safe inks designed specifically for tattooing.
- ▶ Avoid contact with freshly tattooed skin. Protect freshly tattooed areas of skin from dirt and from exposure to UV light and sunlight.
- ▶ Check on a regular basis if the HAWK PEN has become visibly contaminated by the return flow of inks or bodily fluids. If this has happened, in addition to regular disinfection, you must perform all the steps described in chapter "Cleaning and maintaining the HAWK PEN" (see Page 30).

2.4 Contra-indications

Tattooing is **not** permitted in case of the following:

- Haemophilia/blood vessel conditions
- Uncontrolled diabetes mellitus
- Treatment of areas of skin with dermatitis complaints (e.g. skin tumours, celoids or extreme celoid tendency, solar ceratosis, warts or moles)

- Feverish infections and infectious diseases such as hepatitis conditions of types A, B, C, D, E or F or HIV
- Immune system diseases
- Epilepsy
- Acute cardio-vascular problems
- Under the influence of alcohol or drugs

In the following cases, tattooing **cannot be performed until such time as normal health** is restored:

- Acute dosages of anticoagulants (e.g. Warfarin, Heparin, Phenprocoumon or Salicylic acid)
- Acute chemotherapy, radiotherapy or high-dosage corticosteroid therapy
- Systemic infections or acute local skin infections (e.g. with the herpes virus)
- Allergy to topical anaesthetics (local anaesthesia)
- Pregnancy and breast-feeding

Temporary locally restricted contra-indications exist in the following cases:

- Eczema, exanthema or open wounds
- Acute conjunctivitis
- Scars less than six months old
- Areas of skin after plastic surgery treatment less than twelve months previously

- Areas of skin after filler injections less than six months previously

If there is the slightest doubt about customer safety, do not commence treatment or terminate treatment immediately and seek medical attention.

The treatment must be terminated immediately in the event of:

- Excessive sensations of pain
- Excessive release of fluids from the wound
- Fainting / dizziness

2.5 Side-effects

In a few cases, the tattooing process may result in minor side effects.

- ▶ Inform the customer about all risks and about the side-effects described below.

Frequent:

- Pain on the day after tattooing
- Inflammation reactions, haematomas, erythema and oedema in the first three to five days after tattooing
- Skin irritations (e.g. itching or heating), which normally wear off during the first 12 to 48 hours after tattooing

Rare:

- Hyper-pigmentation with body's own pigments, in particular on dark skin types, but that disappear completely a few weeks later
- Formation of scabs, small pimples or skin eruptions if skin is not cleaned carefully after tattooing
- Retinoid reaction (slight irritation up to peeling of skin)
- Possible heating of the tattooed area when exposed to PET and MRT radiation
- Contact allergy to ink pigments or allergic reactions to other components of the aseptic ink

Furthermore, the following problems can occur in response to tattooing:

- Ink shade differences
- Pigment loss

2.6 Required qualification

The HAWK PEN may only be used by people who have acquired the following knowledge:

- Basic knowledge of the tattooing process, in particular correct insertion depth and frequency
- Knowledge of the hygiene and safety regulations (see Page 21)
- Knowledge of the impact of tattoo ink below the skin
- Knowledge of the risks and side-effects (see chapters "Contra-indications" on page 22 and "Side-effects" on page 23).

2.7 Intended use











The HAWK PEN is a professional tattooing machine for the application of tattoos to the human skin in dry, clean and smoke-free environments, and under hygienic conditions. It must be prepared, used and maintained in the manner described in these operating instructions. In particular, the applicable provisions for workplace layout must be observed, and all materials used must be sterile.

Intended use also includes thoroughly reading and understanding these operating instructions, in particular the chapter "Important safety notices".

Unintended use is defined as using the HAWK PEN or its accessories in a way not described in these operating instructions, or failing to comply with its operating conditions. In particular the tattooing of mucous membranes, or the eyes, and the tattooing of minors is prohibited.

2.8 Symbols on the product

The following symbols can be found on the HAWK PEN, its accessories or its packaging:

Symbol	Meaning
	Satisfies the requirements of directives 2006/42/EC (machinery directive) and 2004/108/EC (EMC directive)
	Observe instructions for use!
	Manufacturer
	Date of manufacture
	Catalogue number
	Serial number
	Batch code
	Sterilised with ethylene oxide
	Use-by date
	Attention!
	Temperature limit



Humidity limit



Store in a dry place



Fragile



Cannot be use if packaging is damaged



Do not reuse!



Dispose of properly as used electronic equipment!

3 Scope of delivery

- 1 Cheyenne HAWK PEN one-inch
- 1 HAWK PEN TRAY
- 1 Starter kit with various safety cartridges
- 1 Power cable
- 1 Cable adapter (6.3 mm jack to 3.5 mm socket)
- 1 Maintenance kit with replacement O-rings
- 1 Operating instructions

4 Product info about the HAWK PEN

The Cheyenne HAWK PEN is a high-performance device and is much quieter and vibrates less than conventional tattooing machines. It has powerful skin piercing power and frequency.

4.1 Technical data

Nominal voltage	6 to 12.6 V DC
Power intake	4 W
Start-up current	Max. 2.5 A for max. 200 ms
Piercing frequency	70 to 160 Hz
Stroke	3.5 mm
Needle protrusion	0 to 4.5 mm
Electrical connection	3.5 mm jack
Drive	Precision motor – DC
Operating mode	Continuous operation
Diameter	25.4 mm
Length	123 mm
Weight	Approx. 130 g

4.2 Operating conditions

Ambient temperature	+10 to +35°C
Relative humidity	30 to 75%

4.3 Accessories

The following accessories can be purchased from your local specialist retailer:

- Cheyenne safety cartridges
- Cheyenne Power Units
- Cheyenne foot switch
- Handles
- Protective hoses
- Cable adapters
- O-rings in two different sizes

Protective hoses must have a diameter of 26 to 31 mm. This corresponds to a hose width of 40 to 50 mm.

5 Getting the HAWK PEN ready for operation

ATTENTION

Damage from condensate

If the HAWK PEN is exposed to significant variation in temperature, e.g. during transport, condensate can form inside which can damage the electronics.

- ▶ Ensure that the HAWK PEN has reached ambient temperature before using it. If it was exposed to high temperature fluctuations, wait for at least 3 hours for every 10°C of temperature difference before putting it into operation.
- ▶ Only use the HAWK PEN at ambient temperatures of +10 to +35°C.

5.1 Disinfecting equipment

ATTENTION

Damage to drive caused by fluid

If disinfectant gets inside the drive, this can corrode the electrical and mechanical components.

- ▶ Never immerse the drive in disinfectant.

ATTENTION

Product damage caused by non-approved disinfectants

Disinfectants that are not compatible with the materials of the product can damage its surface.

- ▶ Always use disinfectants that are approved, i.e. that comply with stipulations in your country.
- ▶ Note the list of recommended disinfectants in chapter "Material compatibilities" on page 31.
- ▶ Switch off the power supply to the HAWK PEN.
- ▶ Check if the HAWK PEN has been contaminated badly by the return flow of ink or bodily fluids. In such cases, perform the steps described in chapter "Cleaning and maintaining the HAWK PEN" (see Page 30).
- ▶ Wipe down the connecting cables, the drive, the handle and the HAWK PEN TRAY with a soft cloth dipped in disinfectant.

5.2 Replacing the safety cartridge

⚠ WARNING

Risk of injury from needles

Injuries caused by contaminated needles from the safety cartridges can lead to the transmission of disease.

- ▶ Always use genuine Cheyenne safety cartridges for the HAWK PEN. The installed safety membrane on these safety cartridges prevents the ingress of ink into the drive, and also prevents pathogens from entering the appliance.
- ▶ Never hold the safety cartridge by its tip.
- ▶ Switch off the HAWK PEN before changing the safety cartridge.
- ▶ Ensure that when removing a used safety cartridge, no ink remnants can run into the handle.
- ▶ Never push the needles out of the safety cartridge.
- ▶ Check during the removal of a used safety cartridge that the needles are completely retracted into the safety cartridge.

- ▶ Dispose of used safety cartridges that are no longer required for the current application (see chapter "Disposal of equipment" on page 32).
- ▶ The safety cartridges are supplied in sterile packaging. Do not remove them from their packaging until immediately before you intend to use them.
- ▶ Always place the HAWK PEN on the HAWK PEN TRAY so that the safety cartridge does not come into contact with other surfaces.
- ▶ Seek medical attention if injured by a contaminated needle.

- ▶ Switch off the power supply to the HAWK PEN.
- ▶ Insert the safety cartridge in the opening in the handle, as illustrated below.

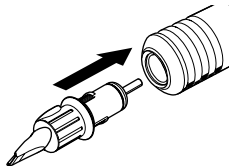

Due to its locating points on the top and bottom, each safety cartridge can only fit in the oval opening in two ways.

- ▶ Rotate the safety cartridge clockwise through approx. 45°.

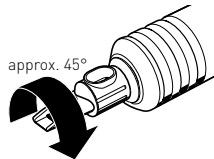

As you rotate it, the four locating points will engage audibly until the safety cartridge is firmly locked into position.

- ▶ Check that the safety cartridge is firmly seated.
- ▶ To remove the safety cartridge, turn it anti-clockwise and remove it from the handle.

5.3 Connecting the power unit

⚠ CAUTION

Risk of short circuits and risk of mild electric shocks

If cable or cable connection is visibly damaged, there is a risk of electric shock and damage to the electronics.

- ▶ Perform a visual inspection of the HAWK PEN and the cable for signs of damage, e.g. a defective cable connection.
- ▶ Never bend the connecting cable while in operation.
- ▶ Observe the operating instructions for the particular power unit.

⚠ CAUTION

Cables constitute a trip hazard

People can stumble over inappropriately routed cables and get injured.

- ▶ Route all cables so that no-one can stumble over them or pull them accidentally.

There are three ways to supply power to the HAWK PEN:

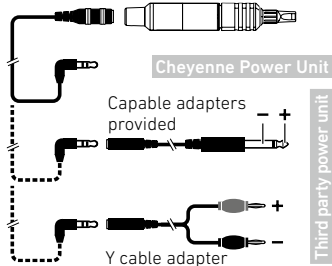

1. Connecting it to a Cheyenne Power Unit with the connecting cable provided in the scope of delivery (recommended)
2. Connecting it to an third-party power unit with the 6.3 mm jack and the cable adapter supplied
The third-party power unit must deliver approx. 6 to 13 V DC. If more than about 13 V is connected to the HAWK PEN, it will shut down automatically.

3. Connection to a third-party power supply using the optionally available Y-cable adapter with banana plugs
The red banana plug must be connected to the positive terminal while the black banana plug must be connected to the negative terminal of the third-party power unit.

- ▶ Connect the socket of the connecting cable (supplied) to the connection on the drive unit of the HAWK PEN.
- ▶ Plug the jack of the connecting cable fully into the output socket on the power unit.
If you are using an third party power unit, connect up its terminals correctly, as described in the operating instructions of the third party power unit.
- ▶ Connect the power unit to the mains power supply.
- ▶ Cover the Power Unit or the third party power unit and the HAWK PEN TRAY with a plastic sheet.

5.4 Fitting the protective hose

ATTENTION

Damage to drive caused by fluid

If fluid gets inside the drive or on the connection, this can corrode the electrical and mechanical components.

- ▶ Always use a protective hose with a diameter of 26 to 31 mm. This corresponds to a hose width of 40 to 50 mm.
- ▶ Remove the connecting cable from the HAWK PEN.
- ▶ Cut off a section of protective hose of an appropriate length.
- ▶ Slide this section of protective hose completely over the connecting cable.
- ▶ Completely unscrew the handle (1) from the drive.

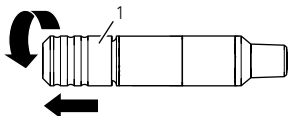

Both O-rings (2 and 3) become visible.

- ▶ Remove the large O-ring (2) and store it safely. The small O-ring (3) remains in its groove.

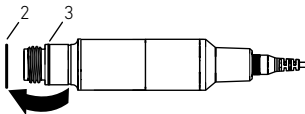

- ▶ Reconnect the connecting cable and its fitted protective hose to the HAWK PEN.
- ▶ Pull the end of the protective hose (4) completely over the HAWK PEN.



- ▶ Slide the large O-ring (2) over the protective hose. Then pull the protective hose with its fitted O-ring back until it locates back in its groove. Ensure that the end of the protective hose locates precisely between the O-rings.

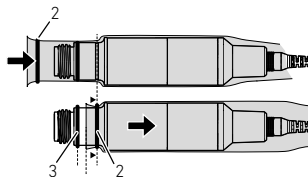

- ▶ If necessary, adjust the position of the protective hose by carefully sliding it under the O-ring. While doing so, the O-rings must not be pulled out of their respective grooves.
- ▶ Screw the handle (1) back onto the thread of the drive unit.

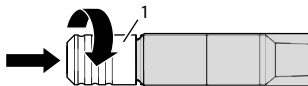

5.5 Checking equipment

- ▶ Conduct a visual inspection of the equipment:
 - Are there any visible signs of external damage (e.g. bends in the connecting cable, a loosened cap near the cable connection)?
 - Are there any exposed cables?
 - Are the safety cartridge and the needles correctly aligned?
- ▶ Switch on the HAWK PEN and conduct a noise test: Can you hear any unusual operating noises, or is the unit running loudly?
- ▶ If you detect anything unusual, refer to chapters "For questions or problems" and "Warranty declaration" on page 33.
- ▶ If the HAWK PEN is no longer operating safely, take it out of service and consult your local specialist retailer.

6 Using the HAWK PEN

6.1 Setting the needle protrusion

⚠ CAUTION

Risk of injury from excessive protrusion of needle

A large needle protrusion permits a deep piercing depth. If needle protrusion and piercing depth are excessive, this can damage the subcutaneous layer.

- ▶ Start with just a short length of needle protruding.
- ▶ Switch on the power.
- ▶ Adjust the needle protrusion while the HAWK PEN is switched on; to do this, turn the handle. Turning clockwise increases the protrusion of the needle:

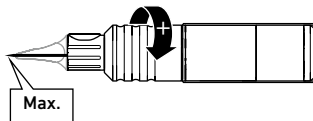

Turning anti-clockwise reduces the protrusion of the needle:

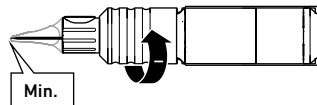

- ▶ Check the needle protrusion on the HAWK PEN.

If the needle protrusion changes accidentally during operation because the handle does not remain fixed in position, then clean the inside of the handle, the thread of the drive, the grooves and the small O-ring thoroughly (see Page 31). If the problem persists, replace the small O-ring in addition (see Page 32). If the problem still persists, consult your local specialist retailer.

6.2 Setting the piercing frequency

⚠ CAUTION

Risk of injury due to high piercing frequency

If the piercing frequency is too high, the skin is cut.

- ▶ Always start at a low piercing frequency, e.g. 70.

- ▶ Switch on the power.
- ▶ Set an appropriate piercing frequency.
The piercing frequency must suit the characteristics of the customer's skin, the needle protrusion and the individual piercing depth when working, as well as the operating speed.

With a Cheyenne Power Unit the piercing frequency can be adjusted in 10 increments using the arrow keys.

With a third-party power unit, the piercing frequency can be adjusted via the output voltage: The permitted voltage range of approx. 6 to 13 V equates roughly to a piercing frequency range of 70 to 160 needle insertions per second. 10 V equates to about 130 needle insertions per second at idle speed. If the output voltage exceeds about 13 V, the HAWK PEN switches off automatically.

6.3 Loading with ink

- ▶ Immediately before use, dip the tip of the safety cartridge in the desired colour of ink for 2 to 3 seconds with the unit running. Avoid contact with the ink container.

The ink is picked up by the needles. Alternatively, the ink can be filled into the opening on the safety cartridge using a sterile pipette.

7 Cleaning and maintaining the HAWK PEN

⚠ CAUTION

Risk of short circuits and risk of mild electric shocks

If components of the HAWK PEN are dismantled and cleaned while still powered, there is a risk of mild electric shock and damage to the electronics in the drive unit.

- ▶ Before starting any cleaning and maintenance work, switch off the power supply to the HAWK PEN.

⚠ ATTENTION

Damage to drive caused by fluid

If cleaning fluid or disinfectant gets inside the drive, this can corrode the electrical and mechanical components.

- ▶ Never immerse the drive in cleaning fluid or disinfectant.

- ▶ Never use an autoclave or an ultrasonic bath to clean the drive and the connecting cable.

- ▶ Pay attention to compatibility of materials when selecting cleaning agents and disinfectants (see the following section)

⚠ ATTENTION

Accidental changes to the needle protrusion length due to greasing

If the handle or O-rings are greased, this may cause the handle to become too easy to turn. That in turn can cause the needle protrusion to be altered accidentally.

- ▶ Never apply grease to the handle or the O-rings.

7.1 Material compatibilities

- Wherever possible, use one of the following disinfectants

Manufacturer	Product	Exposure time
Antiseptica	Big Spray 'new'	1 to 5 mins
Bode Chemie	Bacillol	30 s to 1 min
Ecolab	Incidin Foam	1 to 2 mins
Schülke & Mayr	Mikrozyd Liquid	1 to 2 mins

Based on the following material compatibilities, you can assess which other cleaning agents and disinfectants are suitable

The anodised aluminium components of the HAWK PEN are **resistant** to:

- Weak acids (e.g. acetic acid \leq 10%, citric acid \leq 10%)
- Aliphatic fluorocarbons (e.g. pentane, hexane)
- Ethanol
- Most inorganic salts and their aqueous solutions (e.g. sodium chloride, calcium chloride, magnesium sulphate)

The anodised aluminium components of the HAWK PEN are **not resistant** to:

- Strong acids (e.g. hydrochloric acid, sulphuric acid, nitric acid)
- Oxidising acids (e.g. peracetic acid)
- Lyes (e.g. caustic soda, ammonia and all substances with a pH value $>$ 7)
- Aromatic/halogenised fluorocarbons (e.g. phenol, chloroform) as well as
- acetone and benzene

7.2 Disinfecting surfaces

Before and after each usage:

- Disinfect all surfaces of the HAWK PEN and its accessories as described in chapter "Disinfecting equipment" on page 25.

7.3 Cleaning surfaces

In the event of external contamination:

- Wipe the HAWK PEN and the protective hose with a soft cloth dipped in a cleaning agent or a disinfectant.
- Clean inaccessible surfaces, e.g. the thread of the drive unit, with a soft-bristled nylon brush.

7.4 Cleaning handle in an ultrasonic bath

If the handle is severely soiled:

- Use cleaning agent Tickomed 1 or Tickopur R33 from manufacturer Dr. H. Stamm GmbH in accordance with the manufacturer's instructions in a concentration of 3% in cold water.
- Conduct the cleaning operation for 10 minutes at a frequency of 35 kHz.
- Dry the handle fully after cleaning, before you use it again.

7.5 Sterilising handle in an autoclave

Whenever handle is contaminated:

- Perform all operations described in chapter 'Disinfecting equipment' (see Page 25).
- Autoclave the handle for 20 minutes at a temperature of 121°C and a pressure of 2 bar.
- Dry the handle fully after cleaning, before you use it again.

7.6 Cleaning or replacing O-rings

The large O-ring secures the protective hose. The small O-ring prevents the handle from being turned too easily.

If it is too easy to turn the handle, causing the needle protrusion to alter accidentally, or if the protective hose is no longer held in place firmly enough:

- ▶ Degrease the O-ring with a soft cloth dipped in a cleaning agent or a disinfectant.
- ▶ If the problem persists, replace the O-rings with new ones.

8 Equipment transport and storage conditions

ATTENTION

Damage to product caused by dropping it

If the HAWK PEN is dropped or falls, this can damage its motor and the cap beside the cable connection can come loose, exposing the cable.

- ▶ Always place the HAWK PEN on the HAWK PEN TRAY so that it cannot roll away and/or fall.
 - ▶ If the HAWK PEN does fall or get dropped, conduct a visual inspection of the components and a test for unusual noises.
 - ▶ Hand over the HAWK PEN to a specialist retailer for inspection if it has visible signs of damage, if the operating noise level changes or if it stops functioning normally.
- ▶ Always transport the HAWK PEN and its accessories in their original packaging.

- ▶ Always store the HAWK PEN and its accessories under the following conditions:

Ambient temperature	-40 to +50°C
Relative humidity	30 to 75%
Air pressure	200 to 1060 hPa

9 Disposal of equipment

- ▶ Dispose of the HAWK PEN and accessories bearing the following designation in accordance with  the applicable regulations for used electronic equipment. If necessary, consult the specialist retailer or the responsible authorities to learn about applicable regulations.
- ▶ Provide containers at the workplace for legislation-compliant disposal of contaminated components.
- ▶ Dispose of used or defective safety cartridges in a sharps container (safety box) in accordance with the regulations applicable in your country.

10 For questions or problems

If there is radio interference:

- ▶ First of all, disconnect all components, e.g. the handle and connecting cable, from the HAWK PEN.
- ▶ Check all connections and reassemble the components.
- ▶ Check the functions of the HAWK PEN once again.

If functional problems persist, and if you have any questions or complaints, please contact the specialist retailer responsible.

To obtain information about our current offers, the selection of safety cartridges and accessories, please visit our website www.cheyenne-tattoo.com.

11 Manufacturer declarations

11.1 Warranty declaration

With the Cheyenne HAWK PEN you have purchased a high-quality branded product. The reliability of this device is assured through application of the latest inspection technologies and certification. MT.DERM GmbH is certified in acc. with:

- DIN EN ISO 9001:2008 (quality management system for quality assurance)
- DIN EN ISO 13485:2012 (quality management system for medical products)

For this product, the statutory warranty period of 2 years applies to radio interference problems resulting from defects in material and workmanship.

For the safety cartridges, we guarantee sterility for 5 years subject to sealed and undamaged packaging, and to compliance with transport and storage conditions. For complaints relating to safety cartridges, please advise us of the batch number printed on the label.

We do not provide warranty cover in respect of the following types of damage:

- Damage and secondary damage arising from unintended use or failure to comply with the operating instructions
- Damage arising from the ingress of fluids or dirt into the drive

11.2 Declaration of Conformity

The manufacturer: MT.DERM GmbH
Gustav-Krone-Str. 3
D-14167 Berlin

hereby declares on their own responsibility that the following product:

Name of product: Cheyenne HAWK PEN
Item number: CB-5.10

complies with the stipulations of the following directives:

EMC directive: 2004/108/EC
Machinery directive: 2006/42/EC
RoHS directive: 2011/65/EC

The following harmonised standards were applied:

- DIN EN 60950-1:2014-08: IT equipment - Safety - Part 1: General requirements
- DIN EN 55022:2011-12: IT equipment - Radio disturbance characteristics - Limits and methods of measurement
- DIN EN 61000-6-1:2007-10: Electromagnetic compatibility (EMC) Part 6-1: Generic standards - Immunity for residential, commercial and light-industrial environments
- DIN EN 61000-6-3:2011-09: Electromagnetic compatibility (EMC) Part 6-3: Generic standards - Emission standard for residential, commercial and light-industrial environments
- DIN EN 1037:2008-11: Safety of machinery - Prevention of unexpected start-up
- DIN EN ISO 12100:2011-03: Safety of machinery - General principles for design - Risk assessment and risk reduction
- DIN EN 82079-1:2013-06: Preparation of instructions for use - Structuring, content and presentation - Part 1: General principles and detailed requirements

This declaration is issued on behalf of the manufacturer by:
Berlin, 15 December 2014, Jörn Kluge

Signature of CEO or deputy

Cheyenne HAWK PEN